



**Translation of the Original
Operating Manual**

VM 500

Version 06/2016

**Electrostatic Control Unit
for Electrostatic Manual Spray Guns**

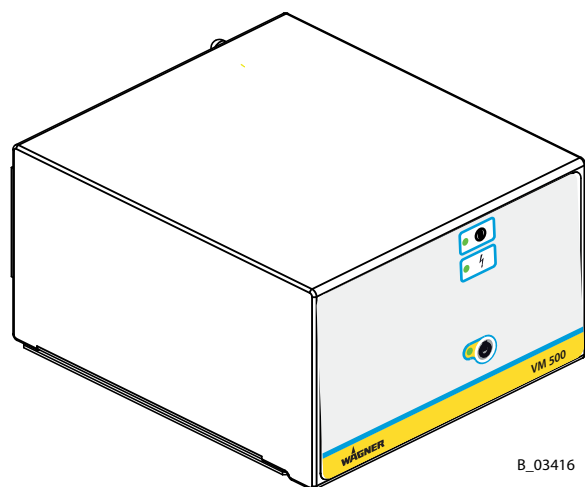

B_03416



Contents

1	ABOUT THESE INSTRUCTIONS	5
1.1	Preface	5
1.2	Warnings, Notices and Symbols in these Instructions	5
1.3	Languages	6
1.4	Abbreviations	6
1.5	Terminology for the Purpose of this Manual	7
2	CORRECT USE	8
2.1	Device Type	8
2.2	Type of Use	8
2.3	Use in an Explosion Hazard Area	9
2.4	Safety Parameters	9
2.5	Reasonably Foreseeable Misuse	10
2.6	Residual Risks	10
3	IDENTIFICATION	11
3.1	Explosion Protection According to FM	11
3.2	Permissible Device Combinations	11
3.3	Type Plate	12
4	GENERAL SAFETY INSTRUCTIONS	13
4.1	Safety Instructions for the Operator	13
4.1.1	Electrical Equipment	13
4.1.2	Personnel Qualifications	13
4.1.3	Safe Work Environment	13
4.2	Safety Instructions for Staff	14
4.2.1	Safe Handling of WAGNER Spray Devices	14
4.2.2	Grounding the Device	15
4.2.3	Product Hoses	15
4.2.4	Cleaning and Flushing	16
4.2.5	Handling Hazardous Liquids, Varnishes and Paints	16
4.2.6	Touching Hot Surfaces	17
4.3	Protective and Monitoring Equipment	17
4.4	Use in Areas Subject to Explosion Hazards	17
4.4.1	Safety Regulations	17
5	DESCRIPTION	18
5.1	Components	18
5.2	Mode of Operation	18
5.3	Scope of Delivery	18
5.4	Technical Data	19
5.5	Operating Elements and Connections	20
5.5.1	Operating Elements Front Side	20
5.5.2	Connections on the Rear Side	21

Table of Contents

6	ASSEMBLY AND COMMISSIONING	22
6.1	Training Assembly/Commissioning Staff	22
6.2	Storage Conditions	22
6.3	Installation Conditions	22
6.4	Additional Components	23
6.5	Location of the Control Unit	24
6.6	Grounding	25
6.7	Example, AirCoat Spraying System	27
6.8	Verifying a Safe Operational Condition	28
7	OPERATION	29
7.1	Training the Operating Staff	29
7.2	Safety Instructions	29
7.2.1	Emergency Deactivation	30
7.3	Starting Up and Spraying	30
7.4	Standby Mode	31
8	CLEANING AND MAINTENANCE	32
8.1	Cleaning	32
8.1.1	Cleaning Staff	32
8.1.2	Safety Instructions	32
8.2	Maintenance	34
8.2.1	Maintenance Staff	34
8.2.2	Safety Instructions	34
8.2.3	Safety Checks	35
9	TROUBLESHOOTING AND RECTIFICATION	36
10	REPAIR WORK	37
10.1	Repair Personnel	37
10.2	Safety Instructions	37
10.3	Check the Control Unit for Leak-Tightness	37
11	DISPOSAL	38
12	ACCESSORIES	39
13	SPARE PARTS	40
13.1	How Can Spare Parts Be Ordered?	40
13.2	Control Unit VM 500	41
14	WARRANTY AND CONFORMITY DECLARATIONS	43
14.1	Important Notes Regarding Product Liability	43
14.2	Warranty Claim	43
14.3	Notes on National Regulations and Guidelines	44

1 ABOUT THESE INSTRUCTIONS

1.1 PREFACE

The operating manual contains information about safely operating, maintaining, cleaning and repairing the device.

The operating manual is part of the device and must be available to operating and service staff.



The device may only be operated by trained staff and in compliance with this operating manual. Operating and service personnel should be instructed according to the safety instructions.

This equipment can be dangerous if it is not operated according to the instructions in this operating manual.



1.2 WARNINGS, NOTICES AND SYMBOLS IN THESE INSTRUCTIONS

Warning instructions in this operating manual highlight particular dangers to users and to the device and state measures for avoiding the hazard. These warning instructions fall into the following categories:



Danger - immediate risk of danger.
Non-observance will result in death or serious injury.

	 DANGER
	<p>This notice warns you of a hazard! Possible consequences of not observing the warning instructions. The signal word indicates the hazard level.</p> <p>→ The measures for preventing the danger and its consequences.</p>

Warning - possible imminent danger.
Non-observance may result in death or serious injury.

	 WARNING
	<p>This notice warns you of a hazard! Possible consequences of not observing the warning instructions. The signal word indicates the hazard level.</p> <p>→ The measures for preventing the danger and its consequences.</p>

Caution - a possibly hazardous situation.
Non-observance may result in minor injury.

	 CAUTION
	<p>This notice warns you of a hazard! Possible consequences of not observing the warning instructions. The signal word indicates the hazard level.</p> <p>→ The measures for preventing the danger and its consequences.</p>

Notice - a possibly hazardous situation.
Non-observance may result in damage to property.

NOTICE
<p>This notice warns you of a hazard! Possible consequences of not observing the warning instructions. The signal word indicates the hazard level.</p> <p>→ The measures for preventing the danger and its consequences.</p>

Note - provides information about particular characteristics and how to proceed.

1.3 LANGUAGES

The **VM 500** operating manual is available in the following languages:

Language	Order No.	Language	Order No.
German	2356799	English	2344502

Additional languages on request or at: www.wagner-group.com

1.4 ABBREVIATIONS

Stk	Number of pieces
Pos	Position
K	Marking in the spare parts lists
Order No.	Order number
ET	Spare part
SSt	Stainless steel
2K	Two components
VM	Voltage Module

1.5 TERMINOLOGY FOR THE PURPOSE OF THIS MANUAL

Cleaning	Manual cleaning of devices and device parts with cleaning agent
Flushing	Internal flushing of paint-wetted parts with flushing agent
Staff qualifications	
Trained person	Is instructed in the tasks assigned to him/her, the potential risks associated with improper behavior as well as the necessary protective devices and measures.
Electrically trained person	Is instructed by an electrician about the tasks assigned to him/her, the potential risks associated with improper behavior as well as the necessary protective devices and measures.
Electrician	Can assess the work assigned to him/her and detect possible hazards based on his/her technical training, knowledge and experience in relevant provisions.
Skilled person in the context of BGI 764	<p>A person who, based on his/her technical training, experience and recent vocational experience, has sufficient technical knowledge in the area of electrostatic coating and is familiar with the relevant and generally accepted rules of technology so that he/she can inspect and assess the status of devices and coating systems based on workplace safety.</p> <p>→ Additional requirements for skilled persons can also be referred to in TRBS 1203 (2010): Expert knowledge in the areas of protection against excessive pressure, electrical hazards, and explosion protection (where applicable).</p>

2 CORRECT USE

2.1 DEVICE TYPE

Control Unit for controlling GM 5000EA or GM 5000EAC electrostatic spray guns.



2.2 TYPE OF USE

WAGNER's electrostatic control unit VM 500 controls and regulates the high-voltage supply to the GM 5000EA or GM 5000 EAC spray guns used to apply liquid coating media.

The VM 500 may only be operated together with the above-mentioned manual spray guns. If the control unit is operated in combination with devices other than the above-mentioned spray guns, the FM authorization (type approval) ceases to be valid.

These electrostatic manual spray guns are suitable for spraying liquid products, in particular coating products that follow AirCoat or Airspray techniques. Coating products which contain ingredients of explosion class IIA and IIB substances (maximum ignition energy 0.24 mJ) may be used.

WAGNER forbids any other use!

	 WARNING
	<p>Incorrect use! Risk of injury and damage to the device.</p> <p>→ Only connect original WAGNER GM 5000EA/GM 5000EAC spray guns to the VM 500 control unit.</p>

2.3 USE IN AN EXPLOSION HAZARD AREA

The control unit is not suitable for use in the explosion zone.

2.4 SAFETY PARAMETERS

WAGNER accepts no liability for any damage arising from incorrect use.

- Use the device only to work with the products recommended by WAGNER.
- Only operate the device as a whole.
- Do not deactivate safety fixtures.
- Use only WAGNER original spare parts and accessories.



The device may only be operated under the following conditions:

- The operating staff must be trained on the basis of this operating manual.
- The safety regulations listed in this operating manual must be observed.
- The operating, maintenance and repair information in this operating manual must be observed.
- The statutory requirements and accident prevention regulation standards in the country of use must be observed.

The control unit may only be operated if all parameters are set and all measurements/safety checks have been carried out correctly.

2.5 REASONABLY FORESEEABLE MISUSE

The forms of misuse listed below may result in physical injury or property damage:

- use with non-authorized spray guns;
- coating work pieces which are not grounded;
- performing unauthorized conversions or modifications to the device;
- using defective components, spare parts or accessories other than those described in the "Accessories" chapter of this operating manual;
- working with incorrect settings.

2.6 RESIDUAL RISKS

Residual risks are risks which cannot be ruled out even in the event of correct use.

If necessary, warning and prohibition signs at the relevant points of risk indicate residual risks.

Residual risk	Source	Consequences	Specific measures	Lifecycle phase
Skin contact with lacquers and cleaning agents	Handling of lacquers and cleaning agents	Skin irritations, allergies	Wear protective clothing Observe safety data sheets	Operation, maintenance, disassembly
Lacquer in air outside the defined working area	Lacquering outside the defined working area	Inhalation of substances hazardous to health	Observe work and operation instructions	Operation, maintenance

3 IDENTIFICATION

3.1 EXPLOSION PROTECTION ACCORDING TO FM

Authorization (type approval) of FM for Class 1, Division 1 (spray gun)



For electrostatic Finishing applications using class I, group D, spray product

In accordance with 2316160

This device has been manufactured and tested by FM, according to the FM (Factory Mutual) standard "Class Number 7260" (Approval Standard for Electrostatic Finishing Equipment). All tested combinations of devices including accessories are given in the FM Control Document with part number 2316160.

3.2 PERMISSIBLE DEVICE COMBINATIONS

The following spray guns may be connected to the VM 500 control unit:

- | |
|------------------------|
| ● GM 5000EA spray gun |
| ● GM 5000EAC spray gun |

Other gun types may only be connected to the control unit after first checking their suitability with Wagner.

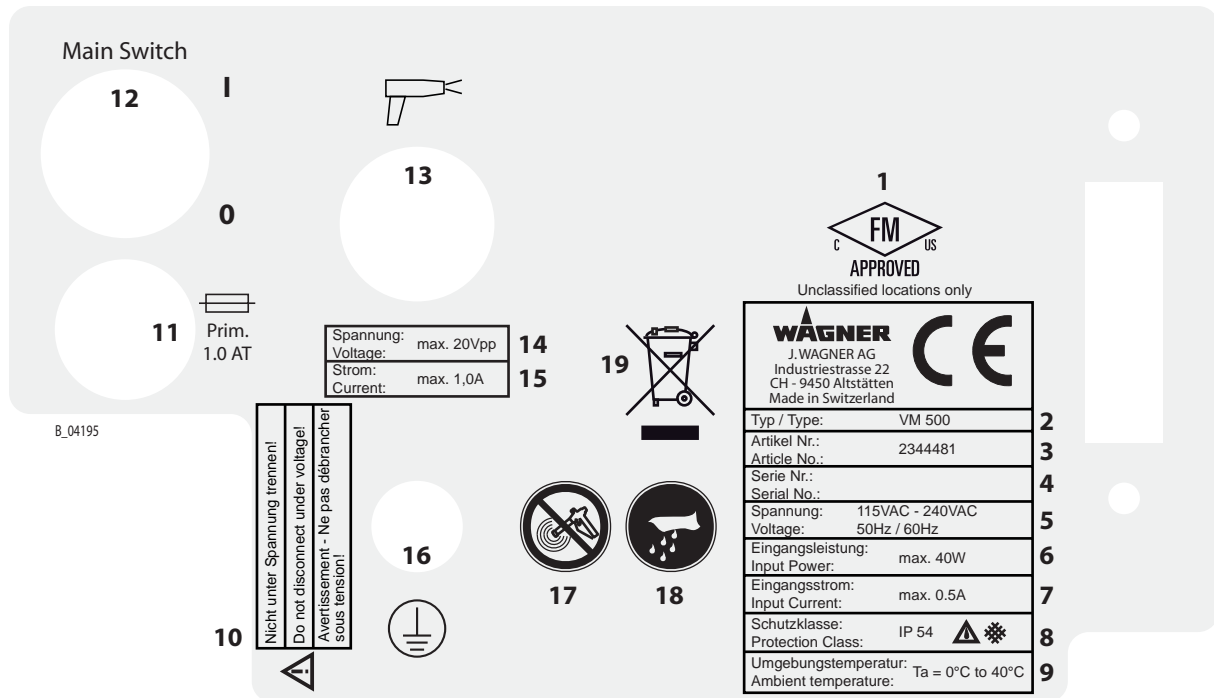
3.3 TYPE PLATE

- | | | | |
|----|----------------------------------|----|------------------------------------------------------------------------------------|
| 1 | FM Identification | 11 | Primary fuse 1.0 ampere slow-acting |
| 2 | Device type | 12 | Mains supply switch |
| 3 | Article number | 13 | Gun connection |
| 4 | Serial number | 14 | Maximum voltage |
| 5 | Input voltage | 15 | Maximum current |
| 6 | Input power | 16 | Grounding |
| 7 | Input current | 17 | Never spray device parts using electrostatic equipment (electrostatic spray gun!). |
| 8 | Protection class | 18 | Use only a damp cloth to clean the unit. Remove deposits from the surfaces. |
| 9 | Ambient temperature | 19 | Do not dispose of used electrical equipment with household refuse. |
| 10 | Do not disconnect under voltage! | | |

4 GENERAL SAFETY INSTRUCTIONS

4.1 SAFETY INSTRUCTIONS FOR THE OPERATOR

- Keep this operating manual at hand near the device at all times.
- Always follow local regulations concerning occupational safety and accident prevention.



4.1.1 ELECTRICAL EQUIPMENT

Electrical devices and equipment

- To be provided in accordance with the local safety requirements with regard to the operating mode and ambient influences.
- May only be maintained by skilled electricians or under their supervision. With open housings, there is a danger from line voltage.
- Must be operated in accordance with the safety regulations and electrotechnical regulations.
- Must be repaired immediately in the event of problems.
- Must be decommissioned if they pose a hazard or are damaged.
- Must be de-energized before work is commenced on active parts. Inform staff about planned work. Observe electrical safety regulations.
- Connect all devices to a common grounding point.
- Only operate the device with a properly installed socket with a protective ground wire connection.
- Keep liquids away from electrical devices.



4.1.2 PERSONNEL QUALIFICATIONS

- Ensure that the device is only operated, maintained and repaired by trained persons.

4.1.3 SAFE WORK ENVIRONMENT

- Ensure that the floor in the working area is static dissipative in accordance with EN 61340-4-1 (resistance must not exceed 100 megohms).
- Ensure that all persons within the working area wear static dissipative shoes. Footwear must comply with EN 20344. The measured insulation resistance must not exceed 100 megohms.
- Ensure that during spraying, persons wear static dissipative gloves. Grounding takes place via the spray gun handle.
- If protective clothing is worn, including gloves, it has to comply with EN 1149-5. The measured insulation resistance must not exceed 100 megohms.
- Paint mist extraction systems/ventilation systems must be fitted on site according to local regulations.
- Ensure that the following components of a safe working environment are available:
 - Product/air hoses adapted to the working pressure.
 - Personal safety equipment (breathing and skin protection).

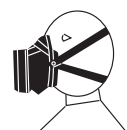

- Ensure that there are no ignition sources such as naked flames, sparks, glowing wires, or hot surfaces in the vicinity. Do not smoke.
- Ensure that the pipe joints, hoses, equipment parts and connections are permanently, technically leak-proof:
 - Periodic preventative maintenance and service (replacing hoses, checking tightness strength and connections etc.).
 - Regular monitoring of leaks and defects via visual inspection and odor testing, e.g., daily before commissioning, at the end of work or weekly.
- In the event of defects, immediately bring the device or system to a stop and arrange to have repairs carried out immediately.

4.2 SAFETY INSTRUCTIONS FOR STAFF

- Always follow the information in this manual, particularly the general safety instructions and the warning instructions.
- Always follow local regulations concerning occupational safety and accident prevention.
- Anyone fitted with a pacemaker must not enter the high-voltage area!



4.2.1 SAFE HANDLING OF WAGNER SPRAY DEVICES

The spray jet is under pressure and can cause dangerous injuries.

Avoid injection of paint or flushing agents:

- Never point the spray gun at people.
- Never reach into the spray jet.
- Before all work on the device, in the event of work interruptions and functional faults:
 - Switch off the energy/compressed air supply.
 - Relieve the pressure from the spray gun and device.
 - Secure the spray gun against actuation.
 - In the event of functional faults, remedy the fault as described in the "Troubleshooting" chapter.
- If necessary or at least every 12 months, the liquid ejection devices should be checked for safe working conditions by an expert (e.g., WAGNER Service Technician) in accordance with the guidelines for liquid ejection devices (ZH 1/406 and BGR 500 Part 2 Chapter 2.29 and 2.36).
 - For shut down devices, the examination can be suspended until the next start-up.
- Carry out the work steps as described in the "Pressure Relief" chapter:
 - If pressure relief is required.
 - If the spraying work is interrupted or stopped.
 - Before the device is cleaned on the outside, checked or serviced.
 - Before the spray nozzle is installed or cleaned.



In the event of skin injuries caused by paint or flushing agents:

- Note the paint or flushing agent that you have been using.
- Consult a doctor immediately.

Avoid risk of injury from recoil forces:

- Ensure that you have firm footing when operating the spray gun.
- Only hold the spray gun briefly in a position.

4.2.2 GROUNDING THE DEVICE

Friction, flowing liquids and air or electrostatic coating processes create charges. Flames or sparks can form during discharge. Grounding prevents electrostatic charging.

- Ensure that the device is grounded. → See chapter "Grounding".
- Ground the work pieces to be coated.
- Ensure that all persons inside the working area are grounded, e.g., that they are wearing static dissipative shoes.
- Wear static dissipative gloves when spraying. The grounding takes place via the spray gun handle.
- The spray substance supply (spray substance tank, pump, etc.) must be grounded.



4.2.3 PRODUCT HOSES

- Ensure that the hose material is chemically resistant to the sprayed products and the flushing agents used.
- Ensure that the product hose is suitable for the pressure generated.
- Ensure that the following information can be seen on the high-pressure hose:
 - Manufacturer
 - Permissible operating pressure
 - Date of manufacture
- Make sure that the hoses are laid only in suitable places. Hoses should not be laid in the following places under any circumstances:
 - in high-traffic areas,
 - on sharp edges,
 - on moving parts or
 - on hot surfaces.
- Ensure that the hoses are never run over by vehicles (e.g., fork lifts), or that the hoses are never put under pressure from the outside in any other way.
- Ensure that the hoses are never kinked. Observe maximum bending radii.
- Make sure that the hoses are never used to pull or move the equipment.
- Suction hoses may not be subjected to pressure.



Several liquids have a high expansion coefficient. In some cases their volume can rise with consequent damage to pipes, fittings, etc. and cause fluid leakage.

When the pump sucks liquid from a closed tank, ensure that air or a suitable gas can enter the tank. Thus a negative pressure is avoided. The vacuum could implode the tank (squeeze) and can cause it to break. The tank would leak and the liquid would flow out.

The pressure created by the pump is a multiplication of the inlet air pressure.

4.2.4 CLEANING AND FLUSHING

- Relieve the pressure from the device.
- De-energize the device electrically.
- Preference should be given to non-flammable cleaning and flushing agents.
- Observe the specifications of the paint manufacturer.
- Ensure that the flash point of the cleaning agent is at least 15 K above the ambient temperature or that cleaning is undertaken at a cleaning station with technical ventilation.
- Take measures for workplace safety (see Chapter 4.1.3).
- When commissioning or emptying the device, please note that an explosive mixture may temporarily exist inside the lines and components of equipment:
 - depending on the coating product used,
 - depending on the flushing agent (solvent) used,
 explosive mixture inside the lines and items of equipment.
- Only electrically conductive tanks may be used for cleaning and flushing agents.
- The tanks must be grounded.

An explosive gas/air mixture forms in closed tanks.

- Never spray into a closed tank when using solvents for flushing.

External cleaning

When cleaning the exterior of the device or its parts, also observe the following:

- Disconnect the pneumatic supply line.
- Use only moistened cloths and brushes. Never use abrasive agents or hard objects and never spray cleaning agents with a gun. Cleaning the device must not damage it in any way.
- Ensure that no electrical component is cleaned with nor even immersed into solvent.
- Which cleaning agent is used to clean the spray gun depends on which parts of the spray gun have to be cleaned and which product has to be removed. When cleaning the spray gun, only use **non-polar cleaning agents** to prevent conductive residues on the surface of the spray gun. Should it however, be necessary to use a polar cleaning agent, all residues of this cleaning agent have to be removed by using a non-conductive and non-polar cleaning agent, once the cleaning is finished.

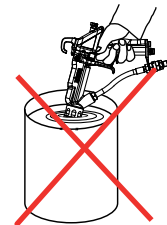

4.2.5 HANDLING HAZARDOUS LIQUIDS, VARNISHES AND PAINTS

- When preparing or working with lacquer and when cleaning the device, follow the working instructions of the manufacturer of the lacquers, solvents and cleaning agents being used.
- Take the specified protective measures, in particular wear safety goggles, protective clothing and gloves, as well as skin protection cream if necessary.
- Use a mask or breathing apparatus if necessary.
- For sufficient health and environmental safety: Operate the device in a spray booth or on a spraying wall with the ventilation (extraction) switched on.
- Wear suitable protective clothing when working with hot products.



4.2.6 TOUCHING HOT SURFACES

- Only touch hot surfaces if you are wearing protective gloves.
- When operating the device with a coating product with a temperature of > 43 °C; 109.4 °F:
 - Identify the device with a warning label "Warning – hot surface".

Order No.

9998910 Instruction label

9998911 Protection label

Note: Order the two stickers together.



4.3 PROTECTIVE AND MONITORING EQUIPMENT

- Protective and monitoring equipment must not be removed, modified or rendered unusable.
- Regularly check for perfect functioning.
- If defects are detected on protective and monitoring equipment, the system must not be operated until these defects are remedied.

4.4 USE IN AREAS SUBJECT TO EXPLOSION HAZARDS

The control unit may not be used in potentially explosive areas. The following safety regulations must be observed and followed.

4.4.1 SAFETY REGULATIONS

- Observe safety instructions in Chapter 3.2.

Surface spraying, electrostatics

- Never spray device parts using electrostatic equipment (electrostatic spray gun!).



Cleaning

If there are deposits on the surfaces, the device may form electrostatic charges. Flames or sparks can form during discharge.

- Remove deposits from the surfaces to maintain conductivity.
- Use only a damp cloth to clean the device.



5 DESCRIPTION

5.1 COMPONENTS

The VM 500 control unit, together with the matching GM 5000EA or GM 5000EAC spray gun and other components, form an electrostatic manual spray system. An example of this kind of spraying system can be found in Chapter 6.7.

5.2 MODE OF OPERATION

The VM 500 control unit supplies the control voltage for the spray gun, in which high-voltage is subsequently produced. The high-voltage supply is switched on and off via the trigger of the spray gun.

The special linear characteristic for high-voltage ensures that if the spray gun is brought too close to the work piece (or ground), the high-voltage is reduced automatically to prevent an accidental spark discharge.

The VM 500 control unit also offers a fault display.

5.3 SCOPE OF DELIVERY

Quantity	Order No.	Designation
1	2344479	VM 500 control unit

The standard equipment includes:

Quantity	Order No.	Designation
1	264626	Mains cable USA; 32 m; 6.56 ft
1	130215	Grounding cable 10 m; 32.8 ft
2	9951117	Delay-action fuse 1.0 AT
1	2316160	FM Control Document GM 5000E
1	2344502	Operating manual VM 500 english

The delivery note shows the exact scope of delivery.

5.4 TECHNICAL DATA

Input voltage	115 VAC - 230 VAC, 50 Hz / 60 Hz
Input power	max. 40 W
Input current	max. 0.5 A
Output voltage	max. 20 Vpp
Output current	max. 1.0 A AC
High-voltage limiting	70 kV DC
Spray current limitation	100 μ A DC
Polarity	for negative high-voltage generators
Protection class	IP 54 *
Weight (without cables)	2.3 kg; 5.07 lb
Ambient temperature	0-40 °C; 32-104 °F

- * Splash water protection is only guaranteed when the gun cable socket is screwed to the device plug and the mains cable plug is fixed to the control unit plug with the safety clip.

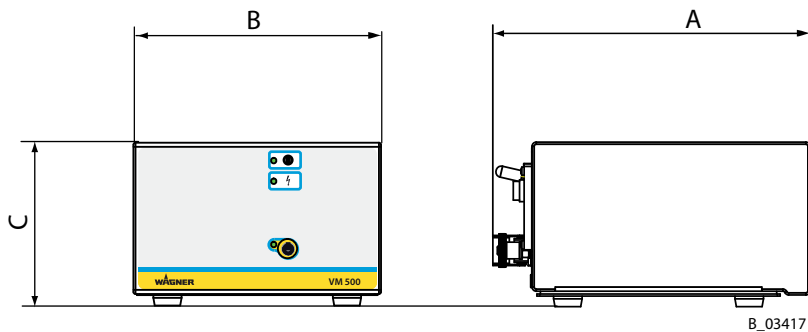
Dimensions

B_03417

VM 500		
	mm	inch
A	230	9.06
B	180	7.09
C	120	4.72

5.5 OPERATING ELEMENTS AND CONNECTIONS

5.5.1 OPERATING ELEMENTS FRONT SIDE

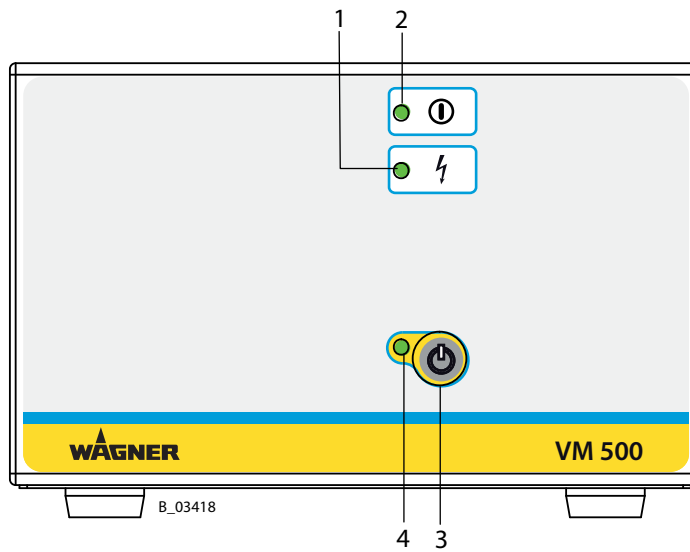

- 1 Illuminated display "High-voltage"
- 2 Illuminated display "Operating signal"
- 3 Push button "Standby Mode"
- 4 Illuminated display "Standby"

5.5.2 CONNECTIONS ON THE REAR SIDE

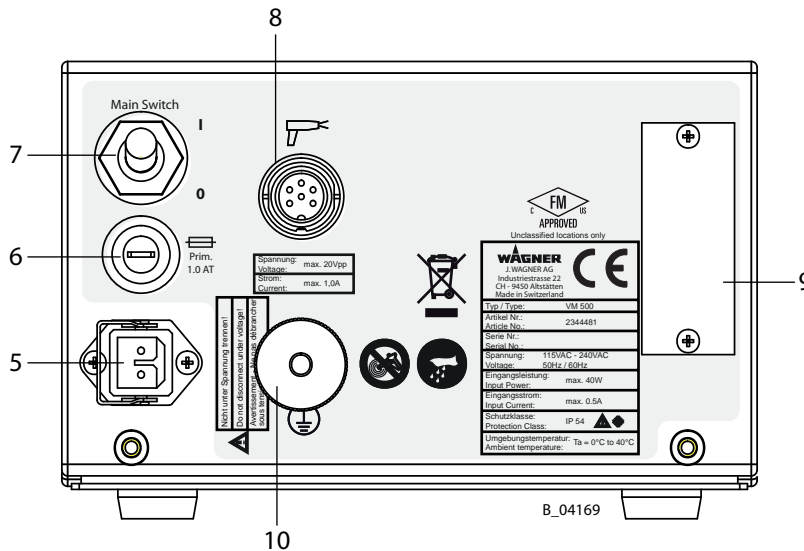

5 Mains input terminal

Connection for mains cable with safety clip.
Warning - Do not disconnect under voltage.

6 Primary fuse

1.0 ampere slow-acting

7 Mains supply switch

0 = The control unit is deactivated.
I = The control unit is activated.

8 Gun connection

To connect a GM 5000EA or GM 5000EAC gun.
Warning - Do not disconnect under voltage.

9 Cover of the service connection



For WAGNER service personnel only.

10 Knurled nut grounding

Grounding cable connection to the signal ground.

6 ASSEMBLY AND COMMISSIONING

6.1 TRAINING ASSEMBLY/COMMISSIONING STAFF

	 WARNING
	<p>Incorrect installation/operation! Risk of injury and damage to the device.</p> <ul style="list-style-type: none"> → The assembly and commissioning staff must have the technical skills to safely commission the device. → When assembling, commissioning and carrying out all work, read and follow the operating manuals and safety regulations for the additionally required system components.

- Do not open the control unit.
- Observe safety instructions in Chapter 4.

A skilled person must check to ensure that the device is in a reliable state after it is installed and commissioned.

6.2 STORAGE CONDITIONS

Until the point of assembly, the device must be stored in a dry location, free from vibrations and with a minimum of dust. The device must be stored in closed rooms.

The air temperature at the storage location must be between -20 °C and +60 °C (-4 °F and +140 °F).

The relative air humidity at the storage location must be between 10 and 95% (without condensation).

6.3 INSTALLATION CONDITIONS

The air temperature at the installation site must be in a range between 0 and 40 °C; 32 and 132 °F.

The relative air humidity at the installation site must be between 10 and 95% (without condensation).

6.4 ADDITIONAL COMPONENTS

This control unit can be used to complete an electrostatic manual spray system. To do so, a suitable spray gun and the relevant components for the selected spray process are required (see WAGNER accessories).

Spray guns that are compatible with the VM 500:

Air-Spray GM 5000EAR or GM 5000EAF

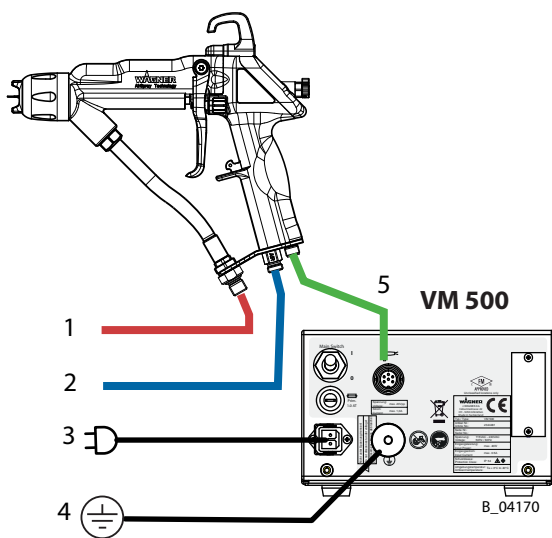

AirCoat-Spray GM 5000EACR or GM 5000EACF

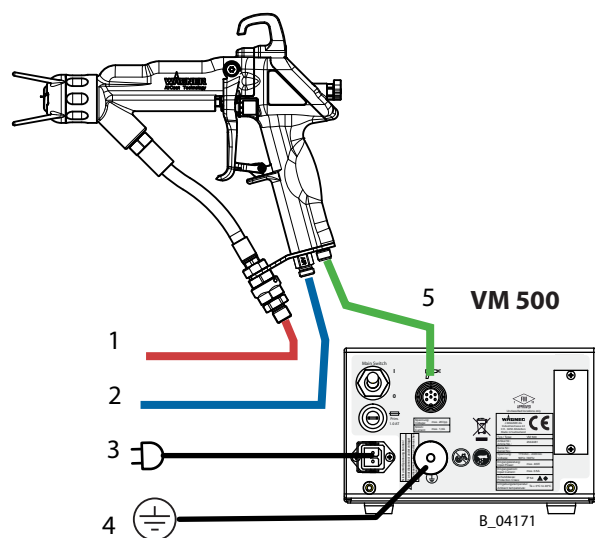



1	for the product supply system	3	Mains cable	5	Gun cable
2	for the compressed air supply	4	Grounding cable to the signal ground		



	<p>! WARNING</p>
	<p>Incorrect installation/operation! Risk of injury and damage to the device.</p> <p>→ When commissioning and for all work, read and follow the operating manual and safety regulations for the additionally required system components.</p>

<p>NOTICE</p>
<p>Impurities in the spraying system! Spray gun blockage, products harden in the spraying system.</p> <p>→ Flush the spray gun and paint supply with a suitable flushing agent.</p>

6.5 LOCATION OF THE CONTROL UNIT



	 DANGER
	<p>Incorrect installation of the device! Explosion hazard and damage to the device.</p> <ul style="list-style-type: none"> → Set up the device outside the spray booth / spray zone. → Place the device outside the Ex zone (placement in Ex zone is not permitted). → Protect the device from significant temperature and moisture changes. → Protect the device from contamination. → Lay and fix the connecting cable correctly. → Ensure that the local mains voltage and tension of the device match.



All sealed elements on the control unit must be present and undamaged. During operation, all electric connections of the control unit have to be tightly sealed with the corresponding plug connectors or closing elements. While under voltage, neither plug connectors nor closing elements may be separated or opened.

	 WARNING
	<p>Sparks form when live components are separated or connected! Explosion hazard from electric sparks.</p> <ul style="list-style-type: none"> → Do not disconnect plug connections under voltage. → Do not open fuse holders under voltage. → Do not remove the service plug cover under voltage.

6.6 GROUNDING

It is important for systems safety and to achieve an optimum coating that all system components such as work pieces, conveyors, paint supply, control unit and booth or spraying stand are perfectly grounded.

	 WARNING
	<p>Discharge of electrostatically charged components in atmospheres containing solvents! Explosion hazard from electrostatic sparks or flames.</p> <p>→ Ground all device components. → Ground the work pieces to be coated.</p>

	 WARNING
	<p>Heavy paint mist if grounding is insufficient! Danger of poisoning. Insufficient paint application quality.</p> <p>→ Ground all device components. → Ground the work pieces to be coated.</p>

A poorly grounded work piece causes:

- Very bad wrap around.
- Uneven coating.
- Back spraying to the spray gun (contamination) and coater.

Prerequisites for perfect grounding and coating are:

- Clean work piece suspension.
- Grounding of spray booth, conveyor system and suspension on the building side in accordance with the operating manuals or the manufacturer's information.
- Grounding of all conductive parts within the working area.
- The grounding resistance of the work piece may not exceed 1 MΩ (megohm).
(Ground leakage resistance measured at 500 V or 1000 V)
- Connect the control unit to the signal ground.
- Connect all ground cables using a short and direct route.
- Safety shoes and gloves, if used, must be static dissipative.

Grounding scheme (example)

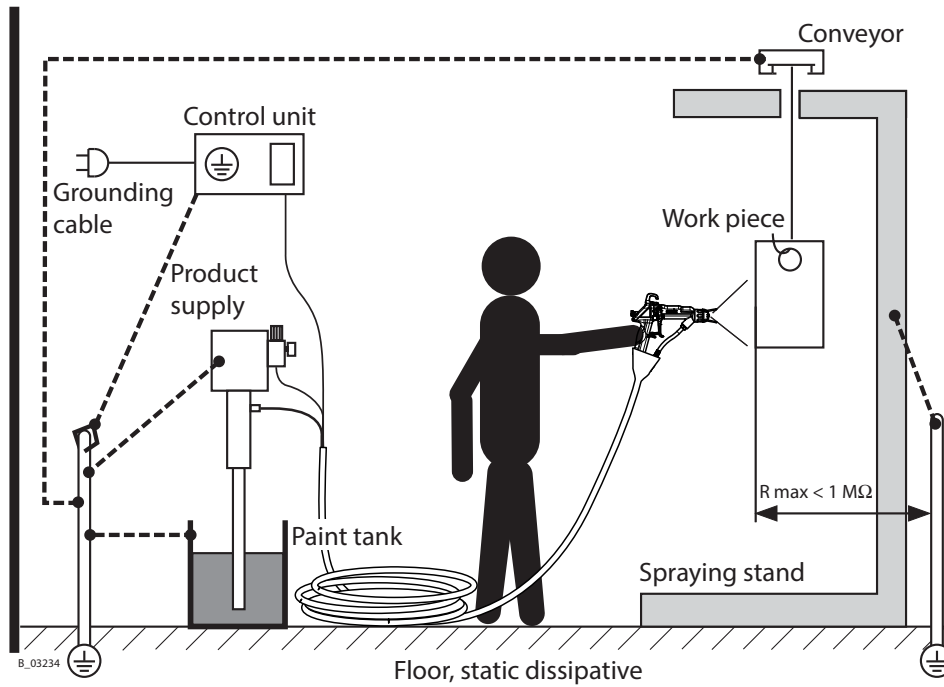

Minimum cable cross-section

Control unit	4 mm ² / AWG 12
Product supply	
Paint tank	
Conveyor	16 mm ² / AWG 6
Booth	
Spraying stand	

Grounding of spray gun

The spray gun is grounded via the spray gun cable.

→ The GM 5000EA or GM 5000EAC spray gun must be connected to the VM 500 control unit via the spray gun cable.

Note for the sprayer

Safety shoes and gloves, if used, must be static dissipative.

6.7 EXAMPLE, AIRCOAT SPRAYING SYSTEM

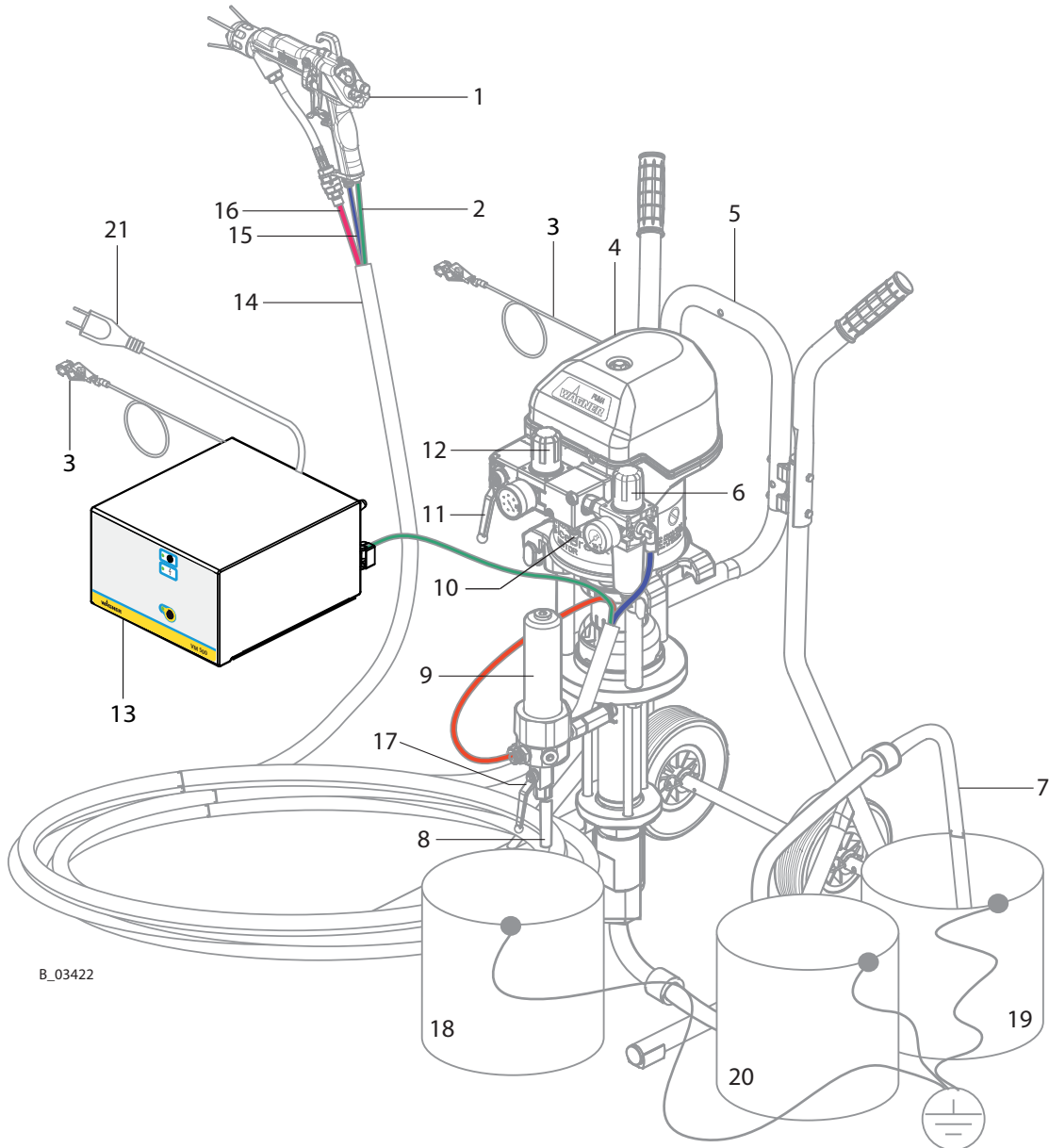

Pos	Description	Pos	Description	Pos	Description
1	GM 5000EACF spray gun	8	Return hose	15	Air hose
2	Gun cable	9	High-pressure filter	16	Product hose
3	Grounding cable	10	Compressed air connection	17	Return valve
4	Pneumatic pump	11	Stop valve	18	Tank for return flow
5	Sliding tables	12	Air pressure regulator	19	Paint tank
6	Air pressure regulator + air filter	13	VM 500 control unit	20	Tank for flushing agent
7	Product suction system	14	Protective hose	21	Mains cable

The following points should be noted before commissioning:

- Lay grounding cable from the grounding screw on the device to the signal ground and ensure that all other conductive parts within the working area are grounded.
- Connect the VM 500 electrostatic control unit via the mains cable to the socket interlocked with the extraction system.
- Connect the gun cable to the connector socket and screw into place.
- Connect the spray gun to the adjustable, clean air supply.
For compressed air quality, see operating manual for spray gun.
- Connect the GM 5000EA or GM 5000EAC to the paint supply as described in the relevant operating manuals.
- Check that all product-conveying connections are correctly connected.
- Check that all air-conveying connections are correctly connected.
- Visually check the permissible pressures for all the system components.
- Check the level of the separating agent in the pump and fill up if necessary.
- Provide product tank, tanks for flushing agent and an empty tank for return flow.
- The interface input on the back of the control unit has to be protected by the cover.
- Connect the system to the air supply.
- When first commissioning the unit → Flush the system in accordance with the operating manuals for the other components.



6.8 VERIFYING A SAFE OPERATIONAL CONDITION

A skilled person must check to ensure that the device and the spraying system are in a safe state after they are installed and commissioned.





7 OPERATION



7.1 TRAINING THE OPERATING STAFF



	 WARNING
	<p>Incorrect operation! Risk of injury and damage to the device.</p> <ul style="list-style-type: none"> → The operating staff must be qualified and fit to operate the entire system. → The operating staff must be familiar with the potential risks associated with improper behavior as well as the necessary protective devices and measures. → Before work commences, the operating staff must receive appropriate system training.

7.2 SAFETY INSTRUCTIONS

- Do not open the control unit.
- Observe safety instructions in Chapter 4.

	 WARNING
	<p>Incorrect operation! Risk of injury and damage to the device.</p> <ul style="list-style-type: none"> → If contact with lacquers or cleaning agents causes skin irritation, appropriate precautionary measures must be taken, e.g., wearing protective clothing. → The footwear worn by operating staff must comply with EN ISO 20344. The measured insulation resistance must not exceed 100 megohms. → The protective clothing, including gloves, must comply with EN ISO 1149-5. The measured insulation resistance must not exceed 100 megohms.

	 WARNING
	<p>Discharge of electrostatically charged components in atmospheres containing solvents! Explosion hazard from electrostatic spark-over.</p> <ul style="list-style-type: none"> → Use gun only with fitted nozzle, air cap and union nut.

	 DANGER
	<p>High-voltage field! Danger to life from malfunction of heart pacemakers.</p> <p>Make sure that persons with pacemakers:</p> <ul style="list-style-type: none"> → Do not work with the electrostatic spray gun. → Don't stay inside the area of the electrostatic spray gun/work piece.

7.2.1 EMERGENCY DEACTIVATION

In the case of unforeseen occurrences, proceed as follows:

1. Switch off control unit.
2. Close the compressed air supply.
3. Relieve pressure according to the operating manual of the product pressure generator.
4. Point the spray gun toward the grounded collecting tray.
5. Pull the trigger of the spray gun until no further pressure is present.

7.3 STARTING UP AND SPRAYING

1. Set main switch to position I.
For approx. 1 second all LED's light up
→ Display test

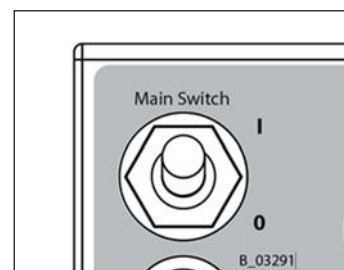

2. If the operating signal light (2) is green after the display test, the control unit is ready to be operated.

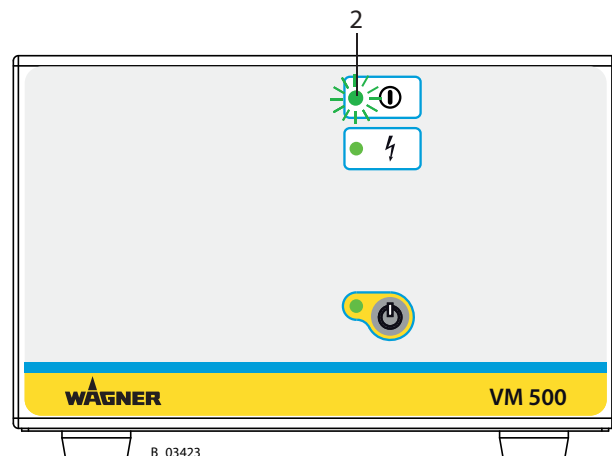

B_03423

3. When the spray gun trigger is pulled, high-voltage is switched on. This is indicated by the high-voltage LED (1).

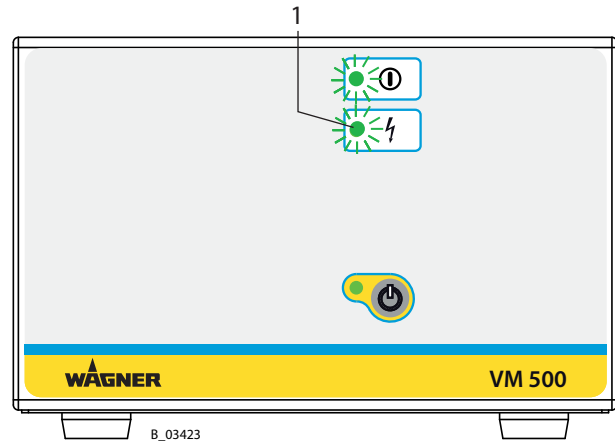

7.4 STANDBY MODE

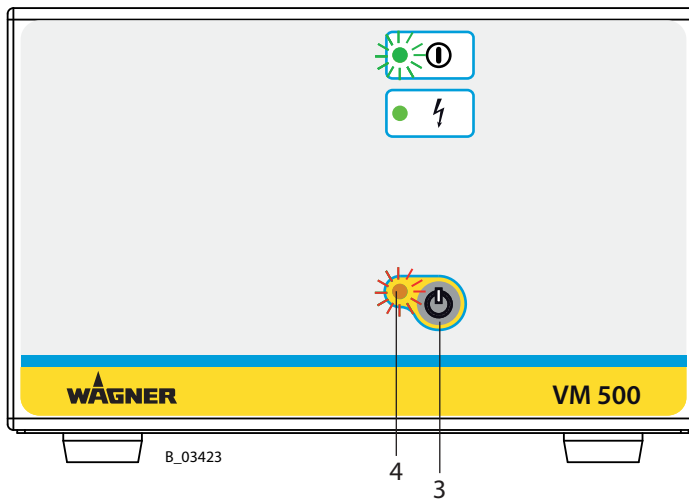

If you want to spray without high-voltage, select the standby mode. Press push button (3) briefly and the "Standby" illuminated display (4) lights up.

Note:

This function can be activated and used from the gun.

8 CLEANING AND MAINTENANCE

8.1 CLEANING

8.1.1 CLEANING STAFF



Cleaning work should be undertaken regularly and carefully by qualified and trained staff. They should be informed of specific hazards during their training.

The following hazards may arise during cleaning work:

- Use of unsuitable cleaning tools and aids

8.1.2 SAFETY INSTRUCTIONS

- Do not open the control unit.
- Observe safety instructions in Chapter 4.



	 DANGER
	<p>Incorrect maintenance/repair! Danger to life and equipment damage.</p> <ul style="list-style-type: none"> → Only a WAGNER service center or a suitably trained person may carry out repairs and replace parts. → Only repair and replace parts that are listed in the Chapter "Spare parts" and that are assigned to the unit. → Before all work on the device and in the event of work interruptions: <ul style="list-style-type: none"> - Switch off the energy supply and the compressed air supply. - Relieve the pressure from the spray gun and device. - Secure the spray gun against actuation. → Observe the operating manual and service manuals at all times when carrying out work.



Cleaning the control unit

If there are deposits on the surfaces, the device may form electrostatic charges. Flames or sparks can form during discharge.

- Remove deposits from the surfaces to maintain conductivity.
- Use only a damp cloth to clean the device.



	 DANGER
	<p>Explosive powder/air mixes! Danger to life and equipment damage.</p> <ul style="list-style-type: none"> → Before starting the cleaning, de-energize the device. → Only electrically conductive tanks may be used for cleaning and flushing agents. Ground the tank. → Clean the control unit with non-flammable cleaning agent. → Ensure that no electric component is cleaned with or immersed into solvent.

	 WARNING
	<p>Incompatibility of cleaning/flushing agent and working medium! Risk of explosion and danger of poisoning by toxic gases</p> <ul style="list-style-type: none"> → Examine the compatibility of the cleaning and flushing agents and working media on the basis of the safety data sheets.

8.2 MAINTENANCE

8.2.1 MAINTENANCE STAFF

Maintenance work should be undertaken regularly and carefully by qualified and trained staff. They should be informed of specific hazards during their training.

The following hazards may arise during maintenance work:

- Use of unsuitable tools and aids

An authorized person must ensure that the device is checked for being in a reliable state after maintenance work is completed.

8.2.2 SAFETY INSTRUCTIONS

→ Observe the safety instructions in Chapter 4 and Chapter 8.1.2.

Prior to maintenance



- Flush and clean the system.



After maintenance

- Carry out a safety check in accordance with Chapter 8.2.3.
- Put the system into operation and check for leaks.

→ In accordance with the guideline for liquid ejection devices (ZH 1/406 and BGR 500 Part 2 Chapter 2.29 and Chapter 2.36):



- The liquid ejection devices should be checked by an expert (e.g., WAGNER service technician) for their safe working conditions as required and at least every 12 months.
- For shut down devices, the examination can be suspended until the next start-up.

	 DANGER
<p>Incorrect maintenance/repair! Danger to life and equipment damage.</p> <p>→ Repair or replacement of devices or parts of devices are only allowed to be performed outside the hazard area by qualified personnel.</p>	

	 DANGER
	<p>Incorrect maintenance/repair! Danger to life and equipment damage.</p> <ul style="list-style-type: none"> → Only a WAGNER service center or a suitably trained person may carry out repairs and replace parts. → Only repair and replace parts that are listed in the Chapter "Spare parts" and that are assigned to the unit. → Before all work on the device and in the event of work interruptions: <ul style="list-style-type: none"> - Switch off the energy supply and the compressed air supply. - Relieve the pressure from the spray gun and device. - Secure the spray gun against actuation. → Observe the operating manual and service manuals at all times when carrying out work.

8.2.3 SAFETY CHECKS

The functionality and completeness of the control unit must be checked regularly. All sealed elements on the control unit must be present and undamaged. During operation, all electric connections of the control unit have to be tightly sealed with the corresponding plug connectors or closing elements.

	 WARNING
	<p>Sparks form when live components are separated or connected! Explosion hazard from electric sparks.</p> <ul style="list-style-type: none"> → Do not disconnect plug connections under voltage. → Do not open fuse holders under voltage. → Do not remove the service plug cover under voltage.

9 TROUBLESHOOTING AND RECTIFICATION

Functional fault	Cause	Remedy
Green illuminated display (2) does not light up No illuminated display lights up	<ul style="list-style-type: none"> - Mains supply not switched on - Fuses defective 	<ul style="list-style-type: none"> - Check and switch on mains supply - Replace fuses - WAGNER Service
Green illuminated display (1) does not light up, no high-voltage	<ul style="list-style-type: none"> - Spray gun cable not connected or defective - Spray gun not connected or defective 	<ul style="list-style-type: none"> - Connect spray gun cable - WAGNER Service
Green illuminated display (1) always lights up	<ul style="list-style-type: none"> - Spray gun or control unit defective 	<ul style="list-style-type: none"> - WAGNER Service
Green illuminated display (1) lights up, no high-voltage	<ul style="list-style-type: none"> - Excessive conductivity of the lacquer 	<ul style="list-style-type: none"> - See operating manual of spray gun

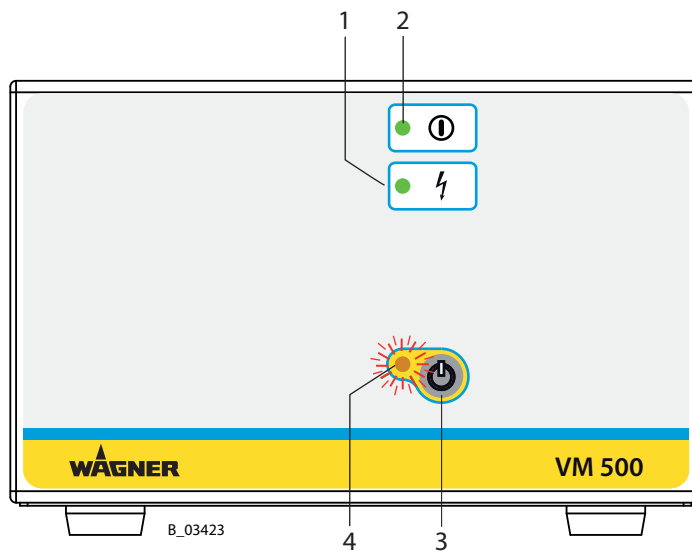

10 REPAIR WORK

10.1 REPAIR PERSONNEL

Repair work should be undertaken carefully by qualified and trained personnel. They should be informed of specific hazards during their training.

The following hazards may arise during repair work:

- Use of unsuitable tools and aids

A skilled person must check to ensure that the device is in a reliable state after it is repaired.



10.2 SAFETY INSTRUCTIONS

→ Observe the safety instructions in Chapter 4 and Chapter 8.1.2.

Before repair: Flush and clean the system.

After a Repair

- Check leak-tightness of control unit as described in Chapter 10.3.
 - Carry out a safety check in accordance with Chapter 8.2.3.
 - Put the system into operation and check for leaks.
- In accordance with the guideline for liquid ejection devices (ZH 1/406 and BGR 500 Part 2 Chapter 2.29 and Chapter 2.36):
- The liquid ejection devices should be checked by an expert (e.g., WAGNER service technician) for their safe working conditions as required and at least every 12 months.
 - For shut down devices, the examination can be suspended until the next start-up.

	 WARNING
	<p>Sparks form when live components are separated or connected! Explosion hazard from electric sparks.</p> <ul style="list-style-type: none"> → Do not disconnect plug connections under voltage. → Do not open fuse holders under voltage. → Do not remove the service plug cover under voltage.

10.3 CHECK THE CONTROL UNIT FOR LEAK-TIGHTNESS

The "Restricted breathing" requirements according to DIN EN 60079-15:2011 have to be fulfilled. When carrying out the leakage tightness test, the mains input terminal serves as a test port.

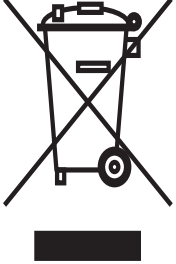

11 DISPOSAL

	<p style="text-align: center;">NOTICE</p> <p>Do not dispose of used electrical equipment with household refuse!</p> <p>In accordance with European Directive 2002/96/EC on the disposal of used electrical equipment and its implementation in national law, this product may not be disposed of with the household refuse, but must be recycled in an environmentally correct manner. WAGNER or one of our dealers will take back your used WAGNER electric or electronic equipment and will dispose of it for you in an environmentally-friendly way. Please contact one of our service points, one of our representatives or us directly to arrange this.</p>
-----------------------------------------------------------------------------------	--------------------------------------------------------------------------------------------------------------------------------------------------------------------------------------------------------------------------------------------------------------------------------------------------------------------------------------------------------------------------------------------------------------------------------------------------------------------------------------------------------------------------------------------------------------------------------------------------------------------------------------------------------------------------------

Consumable products

Consumable products (lacquers, adhesives, flushing and cleaning agents) must be disposed of in accordance with all applicable legal requirements.

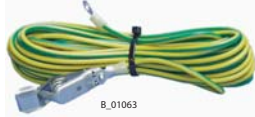
12 ACCESSORIES

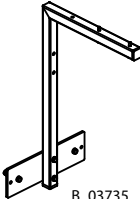
Order No.	Designation	
241270 2330628 241271 264626 264625	Mains cable Europe 3 m; 9.8 ft Mains cable Europe 10 m; 32.8 ft Mains cable Switzerland 3 m; 9.8 ft Mains cable USA 2 m; 6.6 ft Mains cable Japan 3 m; 9.8 ft	 B_01065
130215	Grounding cable 10 m; 32.8 ft	 B_01063
264332	Grounding cable connection 0.75 m; 2.5 ft	 B_01064
2327509	Mounting control unit, complete	 B_03735

Hose sets and spray gun cable

→ see operating manual of spray gun.

13 SPARE PARTS

13.1 HOW CAN SPARE PARTS BE ORDERED?

Always supply the following information to ensure delivery of the right spare part:

Order number, designation and quantity

The quantity need not be the same as the number given in the quantity column "Stk" on the list. This number merely indicates how many of the respective parts are used in each component.

The following information is also required to ensure smooth processing of your order:

- Address for the invoice
- Address for delivery
- Name of the person to be contacted in the event of any queries
- Type of delivery (normal mail, express delivery, air freight, courier etc.)



Identification in spare parts lists.

Explanation of column "K" (labeling) in the following spare parts lists:

- ◆ Wearing parts

Note: These parts are not covered by warranty terms.

- Not part of standard equipment, available, however, as additional extra.

	<p> WARNING</p> <p>Incorrect maintenance/repair! Risk of injury and damage to the device.</p> <ul style="list-style-type: none"> → Repairs and part replacement may only be carried out by specially trained staff or a WAGNER service center. → Before all work on the device and in the event of work interruptions: <ul style="list-style-type: none"> - Switch off the energy/compressed air supply. - Relieve the pressure from the spray gun and device. - Secure the spray gun against actuation. → Observe the operating manuals for any work.
-------------------------------------------------------------------------------------	--------------------------------------------------------------------------------------------------------------------------------------------------------------------------------------------------------------------------------------------------------------------------------------------------------------------------------------------------------------------------------------------------------------------------------------------------------------------------------------------------------------------------------------------------------------------------------------------------------------------------------------------------------------------------------------------------------------------------------------------

Spare parts list for VM 500 control unit

Pos	Stk	Order No.	Designation
1	1	2344479	VM 500 control unit
4	1	9950330	Safety clip for device sockets
5	2	9903306	Recessed head raised fillister head screw, H form
6	1	9910102	Hexagon nut
7	1	9910522	High knurled nut
8	1	9920118	Washer
9	1	9922017	Serrated lock washer, externally toothed
10	2	9903311	Recessed head raised fillister head screw, H form
11	1	241323	Cover, white
12	1	2350437	Print complete VM 500 FM ET
13	3	263400	Distance bush
14	3	9922011	Serrated lock washer, externally toothed
15	3	9910103	Hexagon nut
16	5	2312348	Hexagon lock nut
17	4	9922011	Serrated lock washer, externally toothed
18	4	9903312	Recessed head raised fillister head screw, H form
19	8	2306405	Recessed countersunk flat head screw, Z form
20	1	2307315	Seal
21	1	2307309	Cover
22	4	9990839	Buffer
23	1	9955176	Switching power supply
24	5	2309112	Spacer
26	1	2317598	Print complete VM 500 display
29	1	9953536	2-pin toggle switch
30	1	9952587	Connector plug
31	1	9955021	Fuse socket
32	2	9951117	Delay-action fuse 1.0 AT
33	1	9971519	Rubber seal
34	1	9955601	Fast-acting fuse, 2.5 A
35	1	2325264	Seal

14 WARRANTY AND CONFORMITY DECLARATIONS

14.1 IMPORTANT NOTES REGARDING PRODUCT LIABILITY

As a result of an EC regulation effective from January 1, 1990, the manufacturer shall only be liable for his product if all parts originate from him or are approved by him, and if the devices are properly mounted, operated and maintained.

The manufacturer will not be held liable or will only be held partially liable if third-party accessories or spare parts have been used.

With genuine WAGNER accessories and spare parts, you have the guarantee that all safety regulations are complied with.

14.2 WARRANTY CLAIM

Full warranty is provided for this device:

We will at our discretion repair or replace free of charge all parts which within 24 months in single-shift, 12 months in 2-shift or 6 months in 3-shift operation from date of receipt by the purchaser are found to be wholly or substantially unusable due to causes prior to the sale, in particular faulty design, defective materials or poor workmanship.

The type of warranty provided is such that the device or individual components of the device are either replaced or repaired as we see fit. The resulting costs, in particular shipping charges, road tolls, labour and material costs will be borne by us except where these costs are increased due to the subsequent shipment of the device to a location other than the address of the purchaser.

We do not provide warranty for damage that has been caused or contributed to for the following reasons:

Unsuitable or improper use, faulty assembly or commissioning by the purchaser or a third party, normal wear, negligent handling, defective maintenance, unsuitable coating products, substitute products and the influence of chemical, electrochemical or electrical agents, except when the damage is attributable to us.

Abrasive coating products such as red lead, emulsions, glazes, liquid abrasives, zinc dust paints and so forth reduce the service life of valves, packings, spray guns, nozzles, cylinders, pistons etc. Signs of wear traced back to these products are not covered by this warranty. Components that have not been manufactured by WAGNER are subject to the original warranty of the manufacturer.

Replacement of a component does not extend the period of warranty of the device.

The device should be inspected immediately upon receipt. To avoid losing the warranty, we or the supplier company are to be informed in writing about obvious faults within 14 days upon receipt of the device.

We reserve the right to have the warranty compliance met by a contracting company.

The services provided by this warranty are dependent on evidence being provided in the form of an invoice or delivery note. If the examination discovers that no warranty claim exists, the costs of repairs are charged to the purchaser.

It is clearly stipulated that this warranty claim does not represent any constraint on statutory regulations or regulations agreed to contractually in our general terms and conditions.

J. Wagner AG

14.3 NOTES ON NATIONAL REGULATIONS AND GUIDELINES

- a) TRBS 2131 Technical rule for operating safety
- b) BGR 500 Part 2, Chapter 2.36 Working with Liquid Ejection Devices
- c) BGR 500 Part 2, Chapter 2.29 Working with Coating Products
- d) TRBS 2153 Avoiding ignition risks
- e) BGR 180 Equipment for cleaning work pieces with solvents
- f) ZH 1/406 Guidelines for liquid ejection devices
- g) BGI 740 Painting rooms and equipment
- h) BGI 764 Electrostatic coating
- i) BetrSichV Plant Safety Ordinance

Note: All titles can be ordered from Heymanns Publishing House in Cologne, or they can be found on the Internet.

WAGNER



Order No. 2344502
Edition 06/2016

Germany

J. WAGNER GmbH
Otto-Lilienthal-Str. 18
Postfach 1120

D- 88677 Markdorf

Phone +49/ (0)7544 / 5050
Telefax +49/ (0)7544 / 505200
E-mail service.standard@wagner-group.com

Switzerland

J. WAGNER AG
Industriestrasse 22
Postfach 663

CH- 9450 Altstätten

Phone +41/ (0)71 / 757 2211
Telefax +41/ (0)71 / 757 2222

More contact addresses on the internet at:

www.wagner-group.com

Company/Locations/WAGNER worldwide

Subject to changes without notice